















Ref. 036ARTEKPVCAN

DADOS TÉCNICOS

  9 KW	 0,99 - 1,91 Kg/h	 até 240 m ³	 A+ <small>ECOCONSUM</small>
 7,9 KW	 80 M mm	 15 Kg	
 86%	 230 V	 138 Kg	 699 x 611 x 596 mm

Artek P VISION: A característica que o diferencia do Artek P é unicamente o seu **vidro serigrafado**, vidro este que lhe confere um visual mais arrojado.

CARACTERÍSTICAS

- Saída de Fumos: Superior;
- Recuperador de calor com dimensões standard para a maioria das lareiras construídas;
- Fácil instalação, utilização, acendimento e manutenção;
- Laterais e sifão em vermiculite;
- Estrutura em chapa de aço reforçada;
- Possibilidade de funcionamento estanque, através da ligação do ar de admissão diretamente do exterior;
- Sistema SMARTSTOVE incluído:

Termostato sem fios com conexão até 10metros 

Aplicação 4Heat para gestão à distância 

Recetor Pinkey 

FUNCIONALIDADES



OPCIONAL

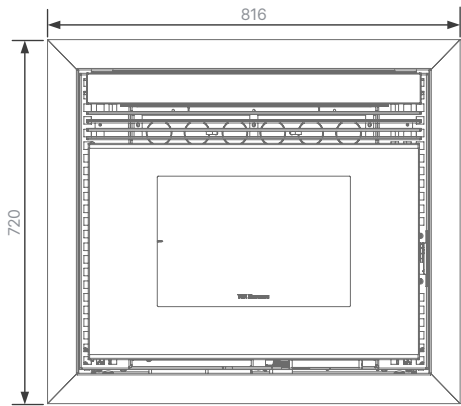

VISTA FRONTAL

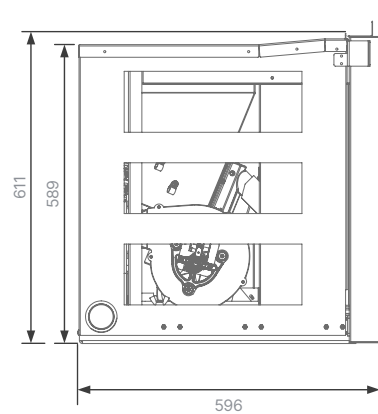

VISTA LATERAL

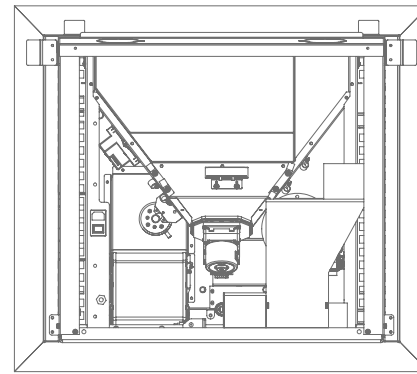



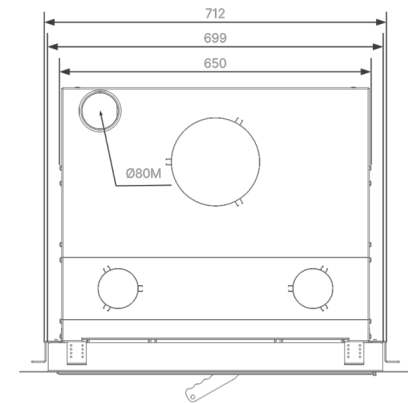









VISTA TRASEIRA



VISTA DE CIMA

DADOS TÉCNICOS

-  |  9 KW
-  0,99 - 1,91 Kg/h
-  até 240 m³
-  A⁺ 
-  7,9 KW
-  80 M mm
-  12 Kg
-  86%
-  230 V
-  138 Kg
-  699 x 611 x 596 mm

